

® in USA

1.4-2.6

TM

PULL THRU

FEEL THE CLEAN



1.4 - 2.6 mm id



≈ 750-2500 mm



 www.pullthru.net.nz

F R Galantai Manufacturing Co. Ltd
11 Bancroft Crescent, Glendene
Auckland, 0602
New Zealand
ISO 13485:2016 Certified Site

EC REP Avena Ltd.
Tower Business Centre, 2nd Flr.,
Tower Street, Swatar,
BKR 4013 Malta

New Zealand Patent Number 540125. Other International Patents Pending.
Copyright © 2018 F R Galantai Manufacturing Co.Ltd.
Trademarks are the property of their respective owners

ADVERSE EVENT REPORTING:

User facilities shall report adverse events to F R Galantai Manufacturing Co. Ltd as well as the competent authority of the EU member state in which the user is established, if applicable.

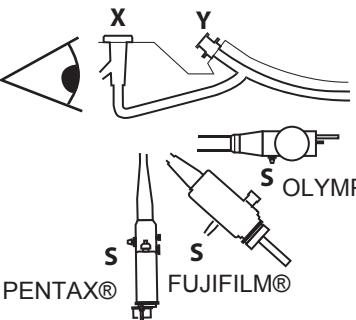
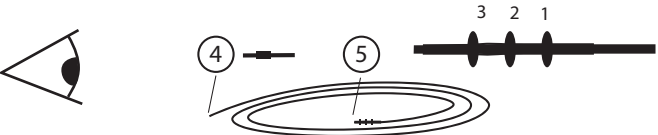

Distal end



Y = 2.6-4.2 mm id
FORM 5142

Y = 2.8-4.8 mm id
FORM 6310

Y = 2.8-5.0 mm id
FORM 5010

FORM 4010 Rev 24 Sept 2021

AA

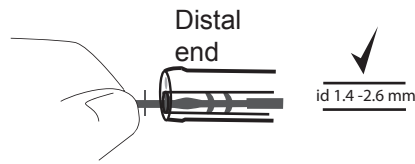

A1

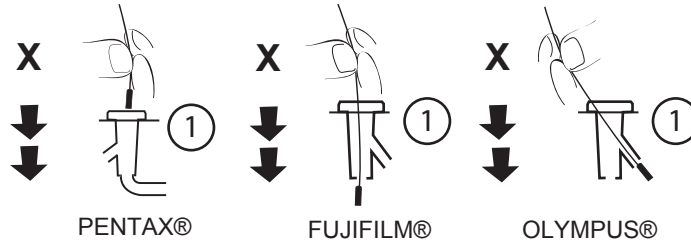

A2

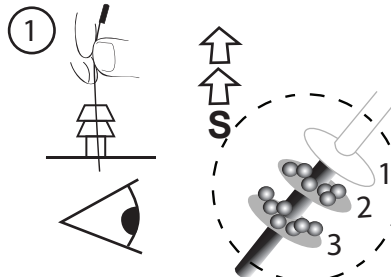

A3

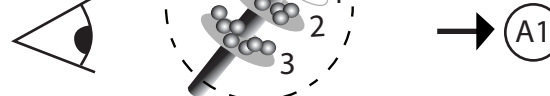

B



FORM 11010

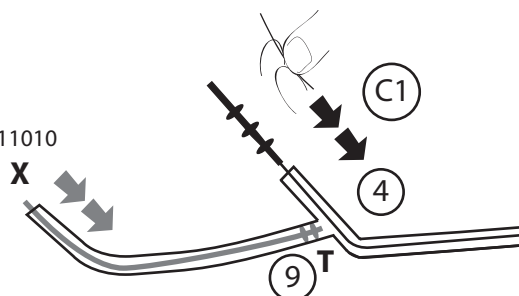

B1

C1

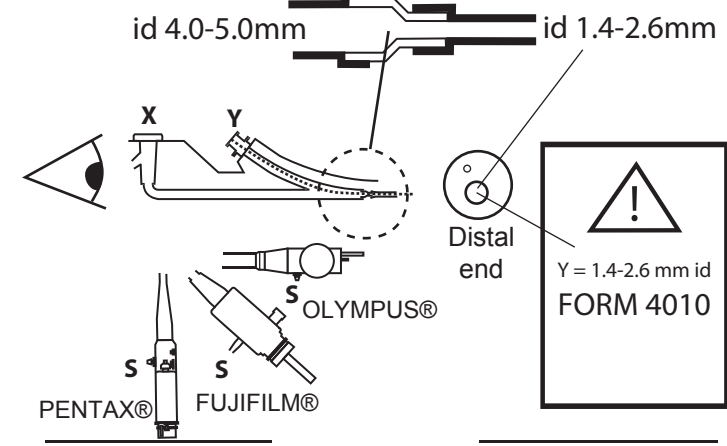
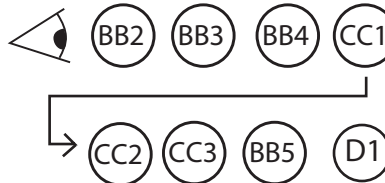

id 4.0-5.0mm

id 1.4-2.6mm

Distal end



Y = 1.4-2.6 mm id
FORM 4010

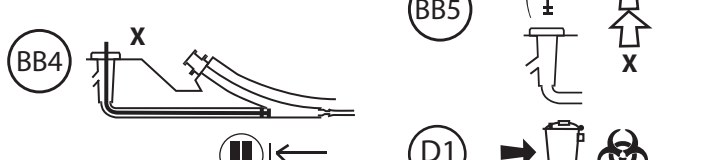
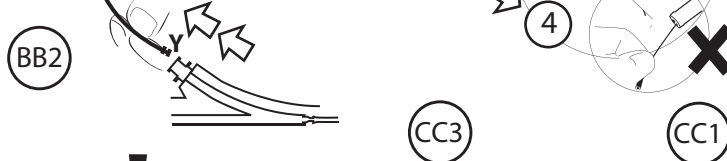
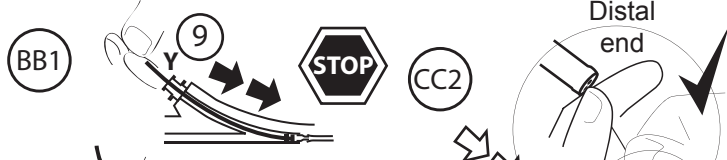
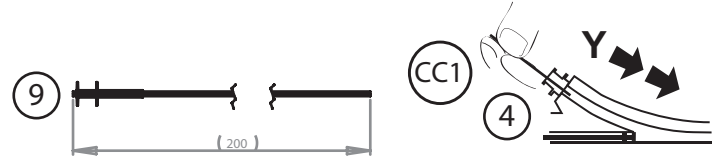
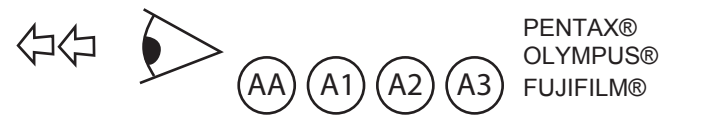

OLYMPUS®

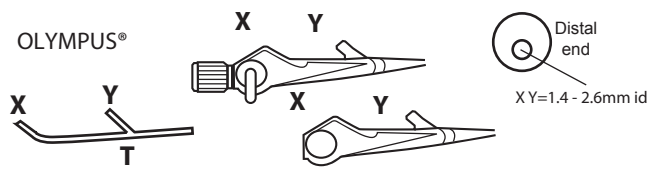

X → T = 2.8-5.0mm



FORM 11010

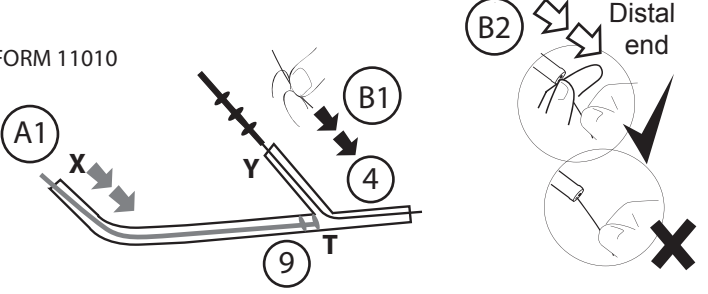

PENTAX®

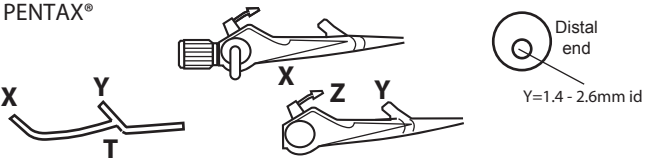

X → T = 2.8-5.0mm



FORM 1101x

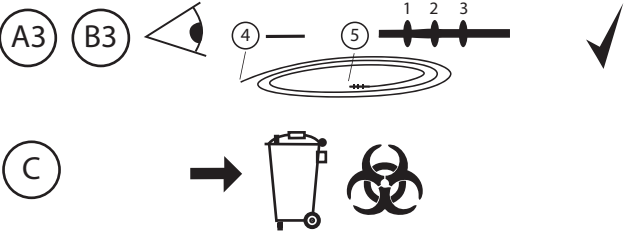
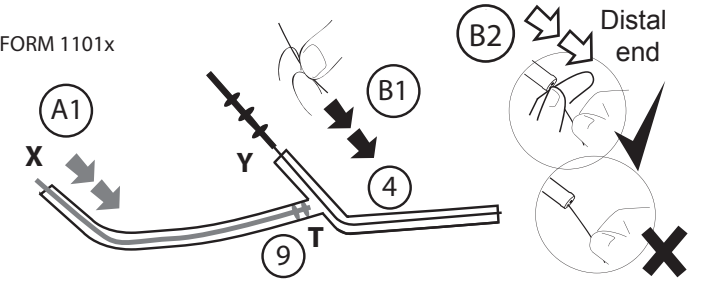

STUBBY BRUSH™



www.pullthru.net.nz

