









2.8-4.8

TM

PULL THRU FEEL THE CLEAN

Single Patient Use Channel Cleaning Brush

2.8 - 4.8 mm id

≈ 750-2500 mm

 Single use only
 USE WET
 Read Instructions before use
 NON STERILE





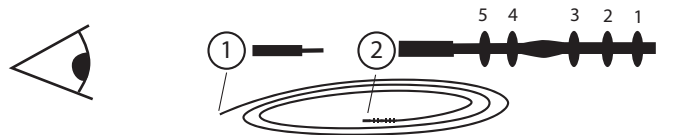

see www.pullthru.net.nz for more information

F R Galantai Manufacturing Co. Ltd
 11 Bancroft Crescent, Glendene
 Auckland, 0602
 New Zealand
 ISO 13485:2016 Certified Site



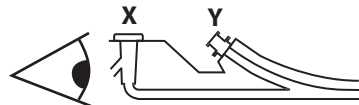

 Advena Ltd.
 Tower Business Centre, 2nd Flr.,
 Tower Street, Swatar,
 BKR 4013 Malta

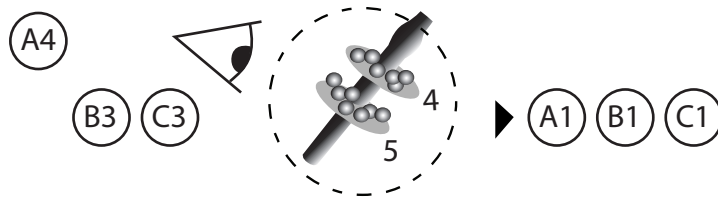
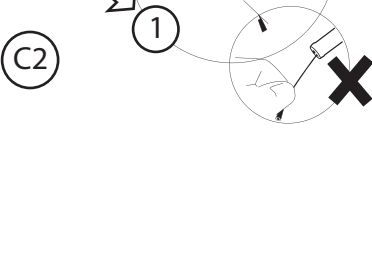
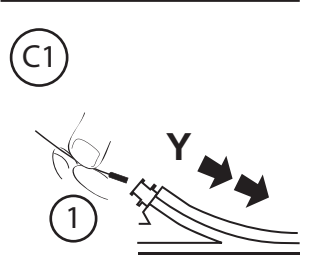
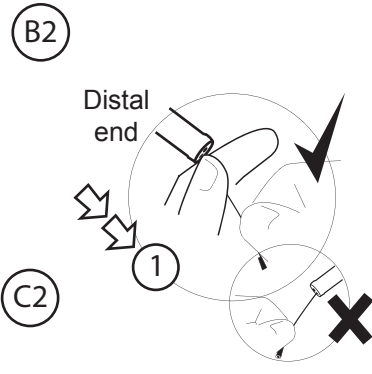
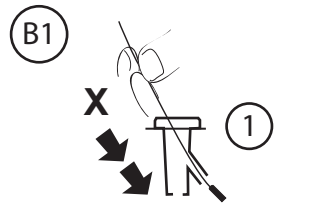
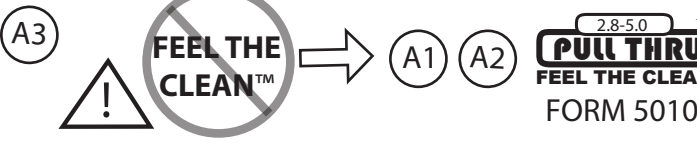
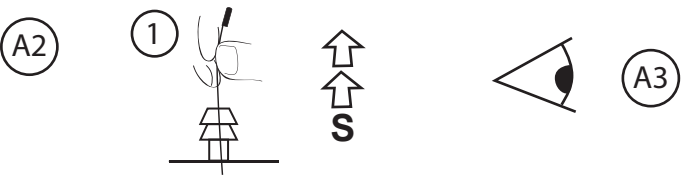
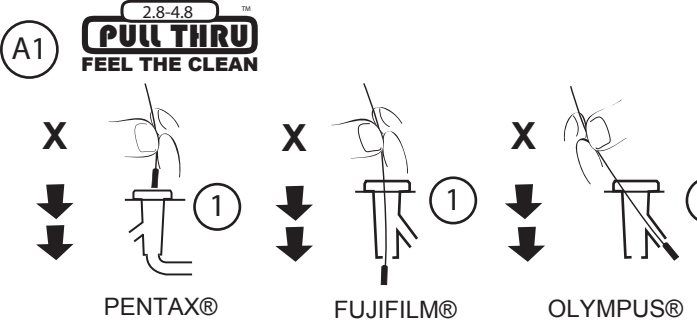
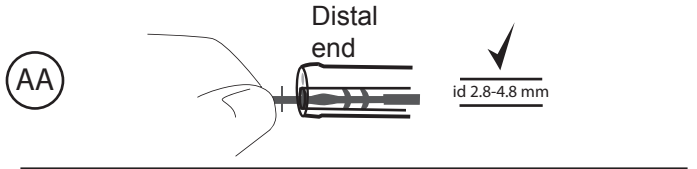

New Zealand Patent Number 540125,
 Other International Patents Pending
 Copyright © 2018 F R Galantai Manufacturing Co.Ltd.
 Trademarks are the property of their respective owners

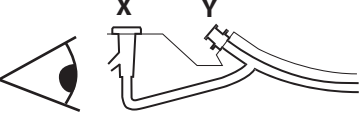





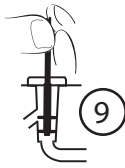

 Y = 1.4-2.6 mm id
PULL THRU
 FEEL THE CLEAN
 FORM 4010
 PENTAX® FUJIFILM® OLYMPUS®
 FORM 5110 Rev 16 May 2020

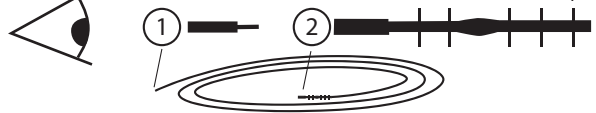
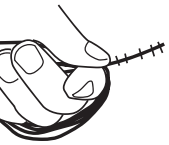
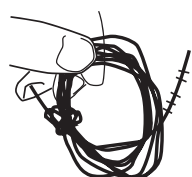

PENTAX® Endoscopes 30, 30k /40

 Distal end
 Y = 1.4-2.6 mm id
PULL THRU
 FEEL THE CLEAN
 FORM 4010
 S

 PENTAX®
 **A1** **A2** **A3**

PENTAX® Endoscopes 30,30k/40 Series
B1

PUSH THRU
 FEEL THE CLEAN
 FORM 11010

 X

 9
 200

 C1 C2 C3

10

 5 4 3 2 1





STUBBY BRUSH™

Single Patient Use Channel Cleaning Brush

